



Watches

All contents of this watch design presentation are owned by Temps De Mode Limited and are protected by copyright under the law of Hong Kong and other countries.

You may not reproduce, transmit, adapt, distribute, sell, modify or publish without prior written consent.



fashiontv

Evening style



Version 1

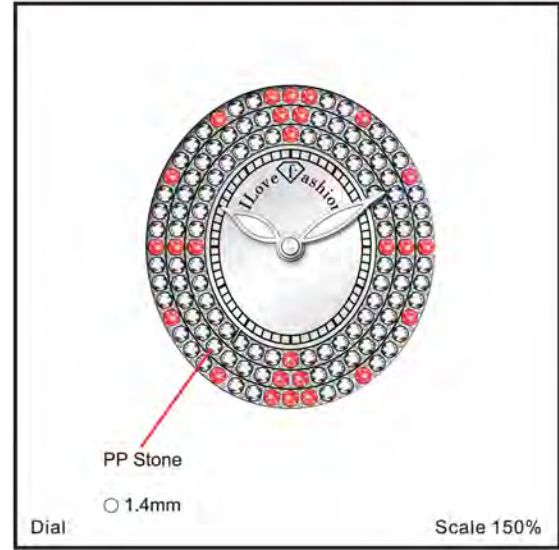

Version 2

- Version 1
- SS case: 34x40.5mm
 - Dial opening: 25.5x28.5mm
 - Shiny Dial
 - Black leather strap: 18mm
 - Crown: Ø 5.5mm
 - Hands: 6.5x9.5mm

- Version 2
- IPG case: 34x40.5mm
 - Dial opening: 25.5x28.5mm
 - Shiny Dial
 - Black leather strap: 18mm
 - Crown: Ø 5.5mm
 - Hands: 6.5x9.5mm



Version 3

- Version 2
- IP rose gold case: 34x40.5mm
 - Dial opening: 25.5x28.5mm
 - Shiny Dial
 - Black leather strap: 18mm
 - Crown: Ø 5.5mm
 - Hands: 6.5x9.5mm

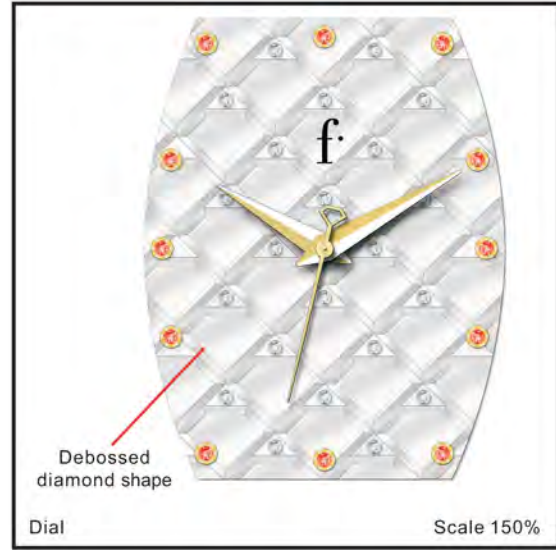

- Version 1
- IPG case: 40x55mm
 - Dial opening: 32x40mm
 - White Dial
 - Black leather strap: 20mm-18mm
 - Crown: Ø 6.5mm
 - Hands: 10x14mm
- Version 2
- SS case: 40x55mm
 - Dial opening: 32x40mm
 - Black Dial
 - White leather strap: 20mm-18mm
 - Crown: Ø 6.5mm
 - Hands: 10x14mm



Version 1

Clear PP Stone
 ○ 2.8mm
 ○ 1.5mm



Version 2



Version 3

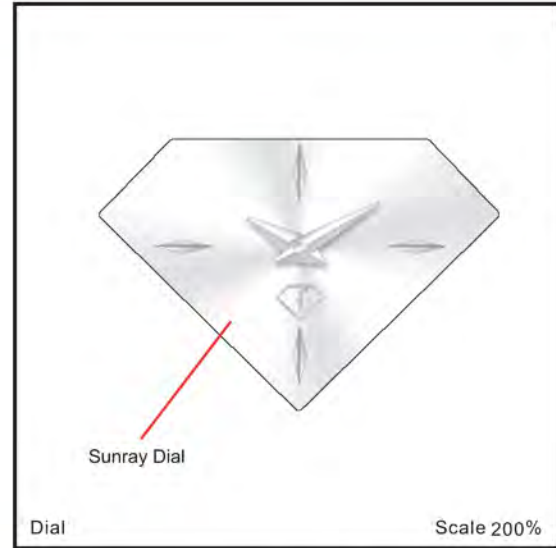

Sunray Dial

Dial

Scale 200%



Side view

Version 1

- SS case: 43x60mm
- Dial opening: 26.5x18mm
- Silver sunray Dial
- SS strap : 28mm
- Crown: Ø 6mm
- Hands: 4x6mm

Version 2

- IP Rose Gold case: 43x60mm
- Dial opening: 26.5x18mm
- Silver sunray Dial
- IP Rose Gold strap : 28mm
- Crown: Ø 6mm
- Hands: 4x6mm

Version 3

- IP Black case: 43x60mm
- Dial opening: 26.5x18mm
- Black sunray Dial
- IP Black strap : 28mm
- Crown: Ø 6mm
- Hands: 4x6mm

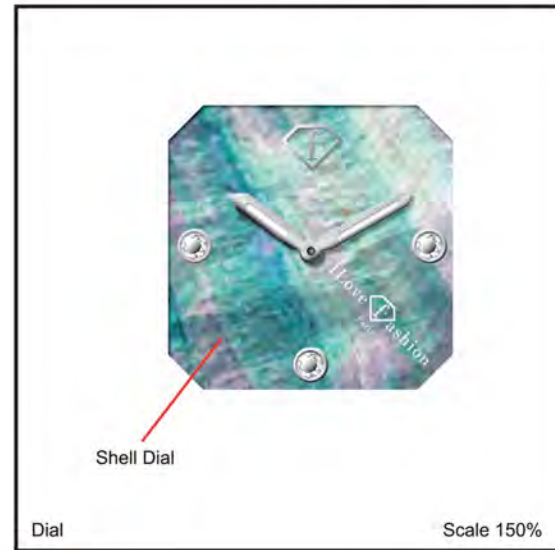
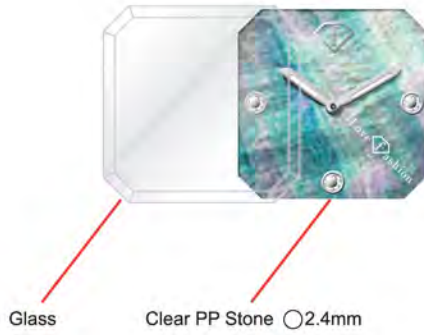

Version 1



Version 2



Version 3

Side view



Version 1

- SS case: 45x45mm
- Dial opening: 25x25mm
- Black Shell Dial
- Stainless Steel Band : 24 to 24mm
- Crown: Ø 4.5mm
- Hands: 7x9mm

Version 2

- IP Black case: 45x45mm
- Dial opening: 25x25mm
- Black Shell Dial
- IP Black Band : 24 to 24mm
- Crown: Ø 4.5mm
- Hands: 7x9mm

Version 3

- IP rose gold case: 45x45mm
- Dial opening: 25x25mm
- White Shell Dial
- IP rose gold Band : 24 to 24mm
- Crown: Ø 4.5mm
- Hands: 7x9mm



Version 1

Clear PP Stone
 ○ 1.5mm

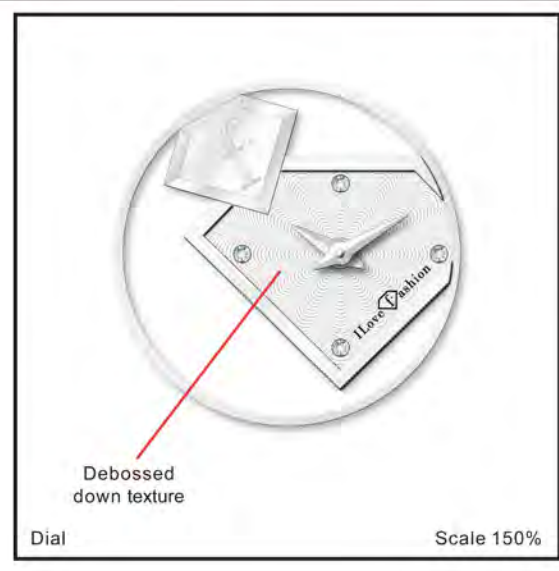

Dial

Scale 150%

Etched logo

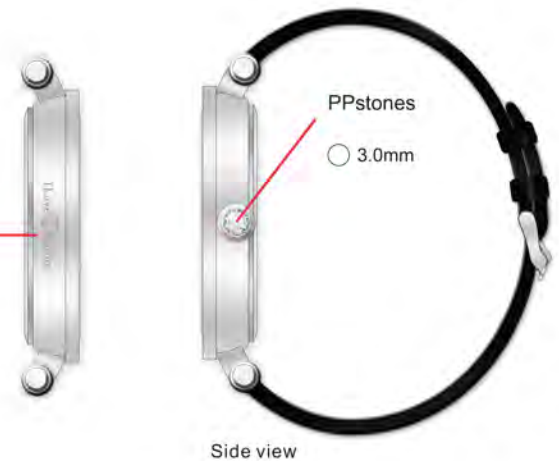

Side view

PPstones
 ○ 3.0mm



Version 2

Version 1

- SS case: 36x44mm
- Dial opening: 29.0mm
- White Dial
- Black leather strap: 18mm to 16mm
- Crown: Ø 5.0mm
- Hands: 4x6.5mm

Version 2

- IPG case: 36x44mm
- Dial opening: 29.0mm
- White Dial
- Black leather strap: 18mm to 16mm
- Crown: Ø 5.0mm
- Hands: 4x6.5mm



Version 1

Clear PP Stone

- 0.9mm
- 1.0mm
- 1.1mm

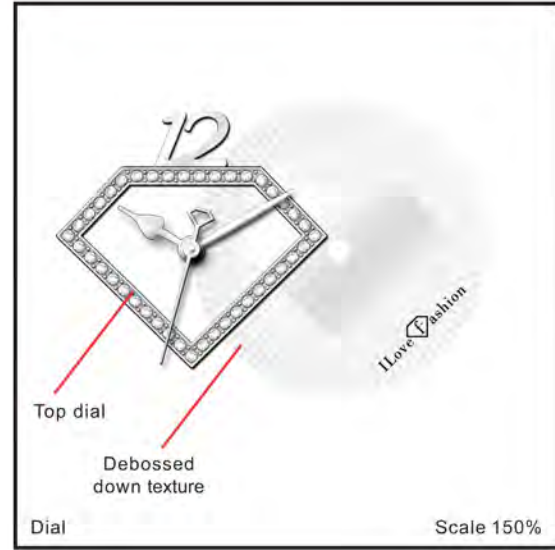

Version 2

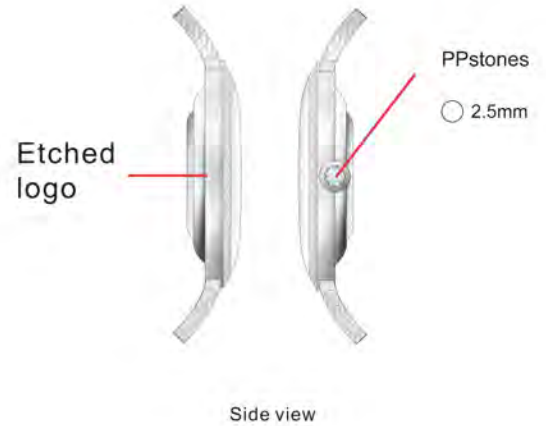

Version 3

Version 1

- SS case: 30x36.5mm
- Dial opening: 25mm
- Stainless steel band: 16mm to 14mm
- Crown: Ø 4.5mm
- Hands: 7.5x10.5mm

Version 2

- IP rose gold case: 30x36.5mm
- Dial opening: 25mm
- IP rose gold caseband: 16mm to 14mm
- Crown: Ø 4.5mm
- Hands: 7.5x10.5mm

Version 3

- IPG case: 30x36.5mm
- Dial opening: 25mm
- IPG band: 16mm to 14mm
- Crown: Ø 4.5mm
- Hands: 7.5x10.5mm

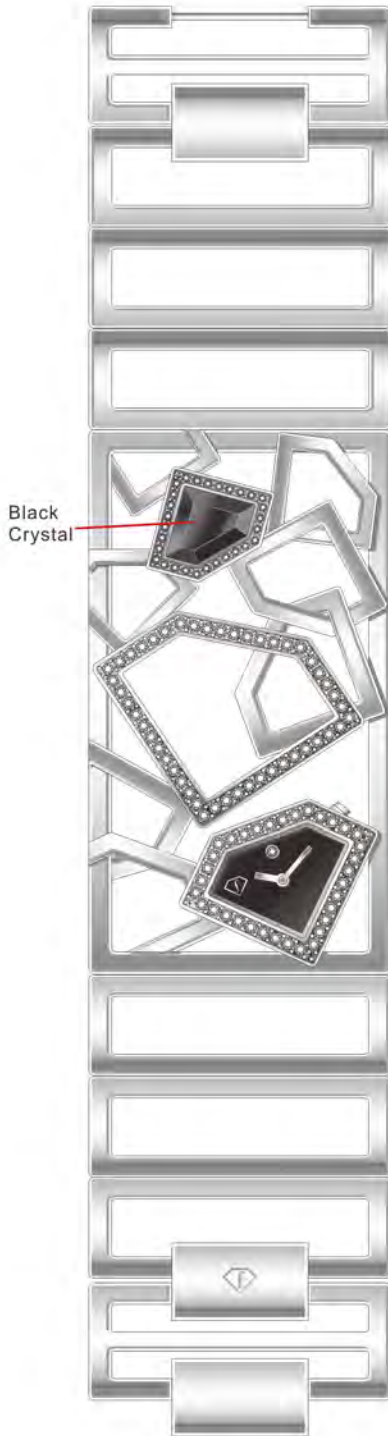

Version 1

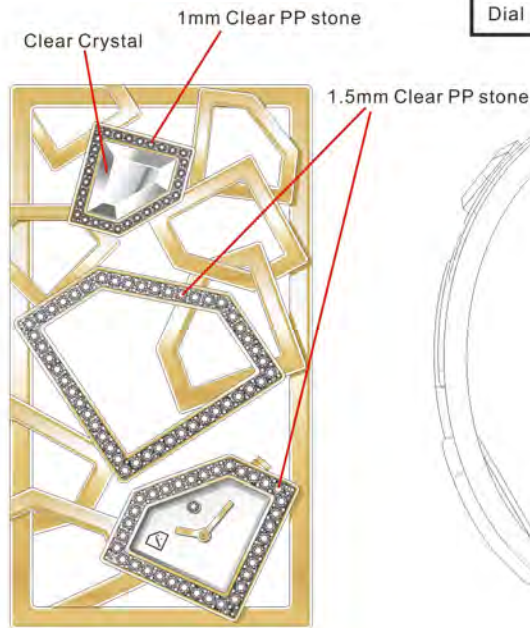

Version 2

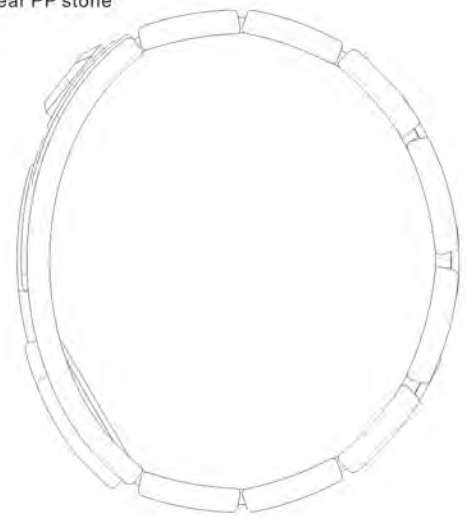
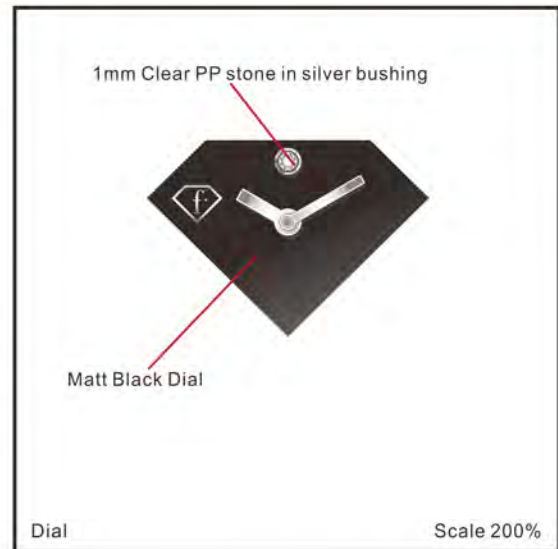

Side view

- SS Case: 28mm(w) x 21mm(l)
- Dial Opening: 18.6mm(w) x 13mm(l)
- SS Bangle: 40mm(w)
- SS Bracelet: 40mm(w)

Version 1

- SS Case with 34 pcs. 1.5mm Clear PP stones
- SS Bangle with 29 pcs. 1mm Clear PP stones + 47 pcs. 1.5mm Clear PP stones
- SS Bracelet
- Matt Black Dial with 1 pc. 1mm Clear PP stone in silver bushing

Version 2

- IPG Case with 34 pcs. 1.5mm Clear PP stones
- IPG Bangle with 29 pcs. 1mm Clear PP stones + 47 pcs. 1.5mm Clear PP stones
- IPG Bracelet
- Matt White Dial with 1 pc. 1mm Clear PP stone in silver bushing



Version 1



Version 2

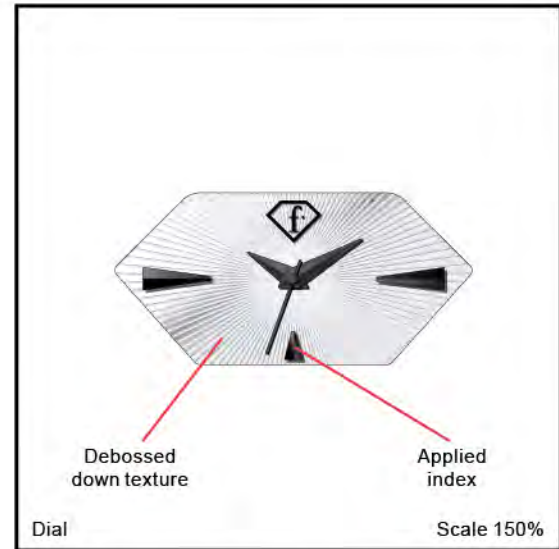

Etched lines

Laser etched logo

Etched lines

Two pieces



Side view

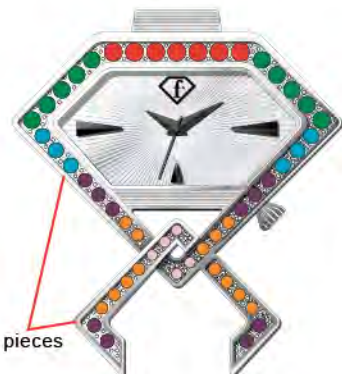

Clear PP stones

- 2.4mm x 7pcs.
- 2.2mm x 10pcs.
- 2.0mm x 6pcs.
- 1.8mm x 10pcs.
- 1.6mm x 13pcs.
- 1.4mm x 5pcs.

Version 1

- SS shiny case: 43.5x36.5mm
- Dial opening: 31.5x15mm
- White debossed down texture dial w/black applied indexes
- Black croco leather strap: 21 taper to 14mm

Version 2

- GP shiny case: 43.5x36.5mm
- Dial opening: 31.5x15mm
- Black debossed down texture dial w/gold applied indexes
- Black croco leather strap: 21 taper to 14mm

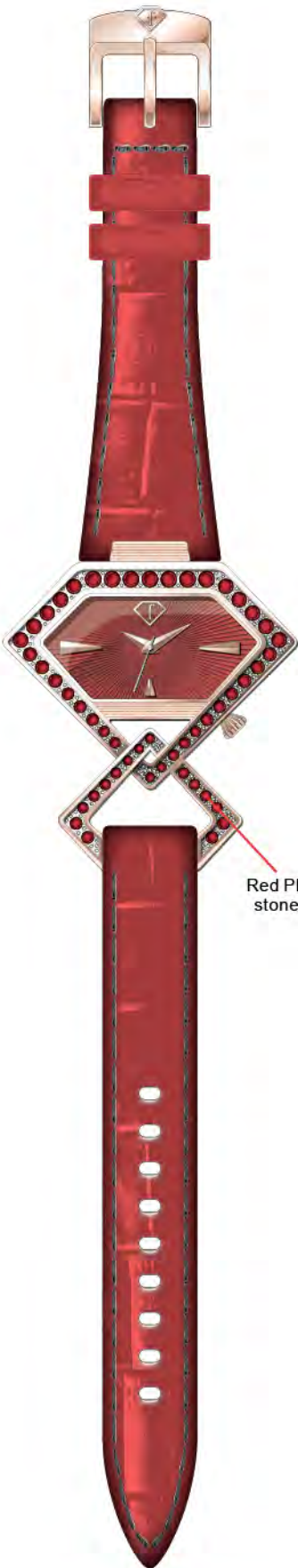

Version 1



Version 2

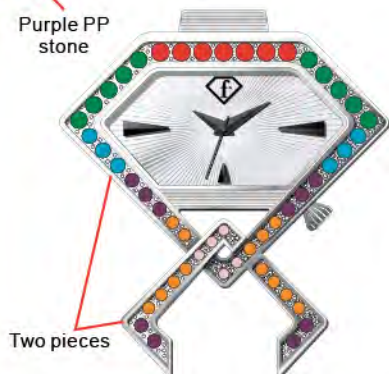
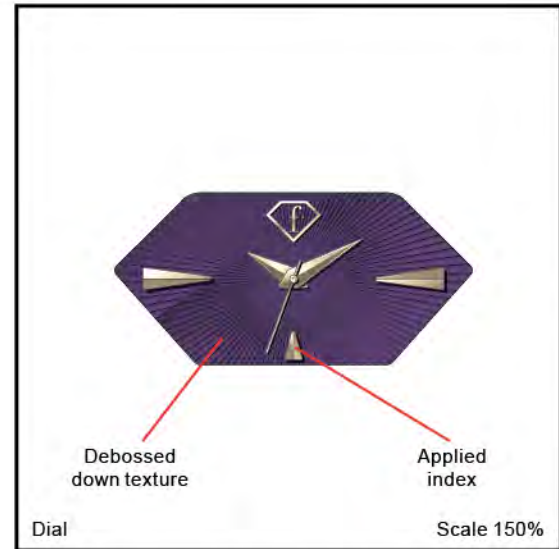

PP stones

- 2.4mm x 7pcs.
- 2.2mm x 10pcs.
- 2.0mm x 6pcs.
- 1.8mm x 10pcs.
- 1.6mm x 13pcs.
- 1.4mm x 5pcs.

Version 1

- IP rose shiny case: 43.5x 36.5mm
- Dial opening: 31.5x15mm
- Red PMS 187C debossed down texture dial w/rose gold applied indexes
- Red PMS 187C croco leather strap: 21 taper to 14mm

Version 2

- GP shiny case: 43.5x 36.5mm
- Dial opening: 31.5x15mm
- Purple PMS 269C debossed down texture dial w/gold applied indexes
- Purple PMS 269C croco leather strap: 21 taper to 14mm



Version1



Version2



Version3

Black Epoxy

Black Epoxy

Black Epoxy



Dial

Faceted Lens

Scale 200%

Version 1

- IPG case:40mmx30.5mm
- Clear faceted lens
- Dial opening:32.5mm x23.7mm
- Matt black sunray dial w/ shiny gold index / logo / (UP labeling)
- IPG links w/ black epoxy
- Links size from 33.5 to 17mm

Version 2

- IPS case::40mmx30.5mm
- Clear faceted lens
- Dial opening:32.5mm x23.7mm
- Matt black sunray dial w/ shiny silver index / logo / (UP labeling)
- IPS inks w/ black epoxy
- Links size from 33.5 to 17mm

Version 3

- IPS case::40mmx30.5mm
- Clear faceted lens
- Dial opening: 32.5mm x 23.7mm
- Matt black sunray dial w/ shiny silver index & shiny gold logo (UP labeling)
- IPS+ IPG links w/ black epoxy
- Links size from 33.5 to 17mm

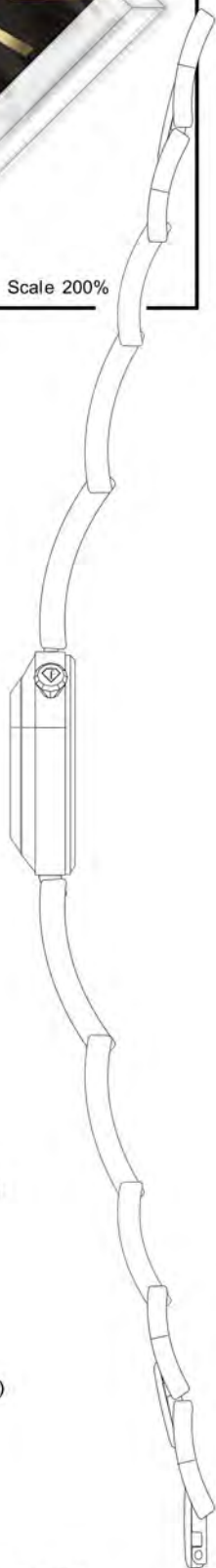

Side view



Trendy style



Version 1



version 2



Version 3

Clear PP Stone
 ○ 1.8mm

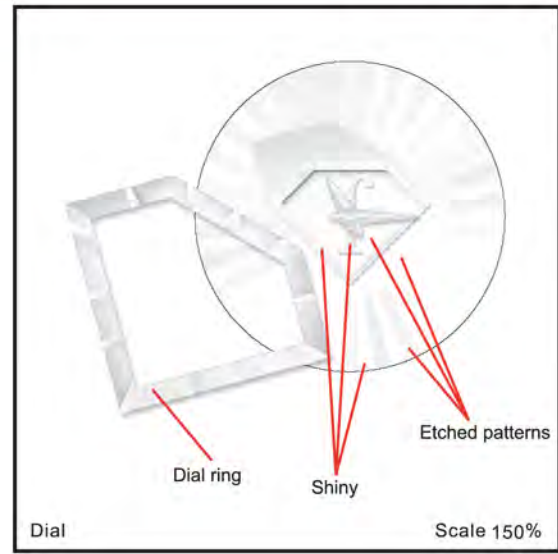

Side view

Version 1

- IP Black case: 38x43mm
- Dial opening: Ø27.5mm
- Black debossed down texture dial
- Black leather strap : 18mm
- Crown: Ø 6mm
- Hands: 4x6mm

Version 2

- SS case: 38x43mm
- Dial opening: Ø27.5mm
- Silver debossed down texture dial
- Hot pink leather strap : 18mm
- Crown: Ø 6mm
- Hands: 4x6mm

Version 2

- IP Rose Gold case: 38x43mm
- Dial opening: Ø27.5mm
- Silver debossed down texture dial
- Blue leather strap : 18mm
- Crown: Ø 6mm
- Hands: 4x6mm



PP Stone
 ○ 1.6mm
 ○ 1.8mm



Dial

Scale 150%



Side view



Version 1



Version 2

Version 1

- White Ceramic case: 38x45mm
- Dial opening: 31.5mm
- White Shell Dial
- White Ceramic Band: 18 to 16mm
- Crown: Ø 5.5mm
- Hands: 9x12.5mm

Version 2

- Black Ceramic case: 38x45mm
- Dial opening: 31.5mm
- White Shell Dial
- Black Ceramic Band: 18 to 16mm
- Crown: Ø 5.5mm
- Hands: 9x12.5mm



Version 1

Version 3

Version 4

Version 2

-SS + Plastic Case: 38mm(w) x 47mm(l)
 -Dial Opening: Ø 28mm
 -Plastic Bracelet: 20mm(w)

- Version 1 (169 pcs. 1mm Clear PP stones)
 -SS + White Plastic Case
 -White Plastic Bracelet
 -Matt White Dial with
 169 pcs. 1mm Clear PP stones
- Version 2 (198 pcs. 1mm Clear PP stones)
 -IP Black + Black Plastic Case
 -Black Plastic Bracelet
 -Matt Black Dial with
 198 pcs. 1mm Clear PP stones
- Version 3 (169 pcs. 1mm Clear PP stones)
 -SS + Hot pink PMS 1925 C Plastic Case
 -Hot Pink Plastic Bracelet
 -Matt Hot Pink Dial PMS 1925 C with
 169 pcs. 1mm Clear PP stones
- Version 4 (198 pcs. 1mm Clear PP stones)
 -IPG + D. Brown PMS 476 C Plastic Case
 -D. Brown Plastic Bracelet
 -Matt D. Brown Dial PMS 476 C with
 198 pcs. 1mm Clear PP stones



Version 1

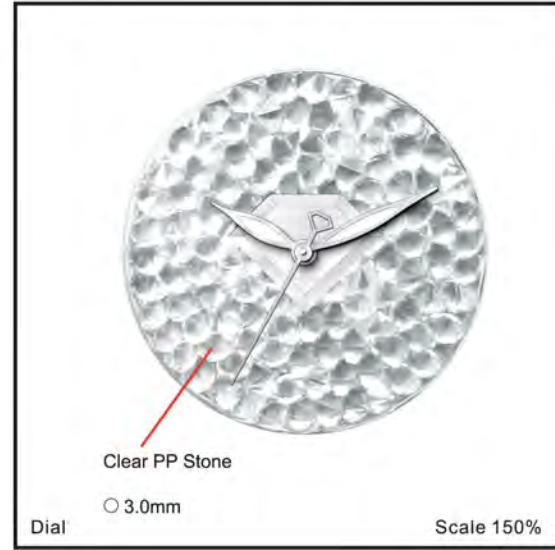

Version 2

- PP Stone
- 1.1mm
 - 1.5mm
 - 3.0mm



Side view



Version 3

Version 1

- SS case: 42x42.5mm
- Dial opening: 29.5mm
- Black leather strap: 20mm to 18mm
- Crown: Ø 5.5mm
- Hands: 9x13mm

Version 2

- IP rose gold case: 42x42.5mm
- Dial opening: 29.5mm
- White leather strap: 20mm to 18mm
- Crown: Ø 5.5mm
- Hands: 9x13mm

Version 3

- IP black case: 42x42.5mm
- Dial opening: 29.5mm
- Black leather strap: 20mm to 18mm
- Crown: Ø 5.5mm
- Hands: 9x13mm



Version 1



Version 2



Version 3

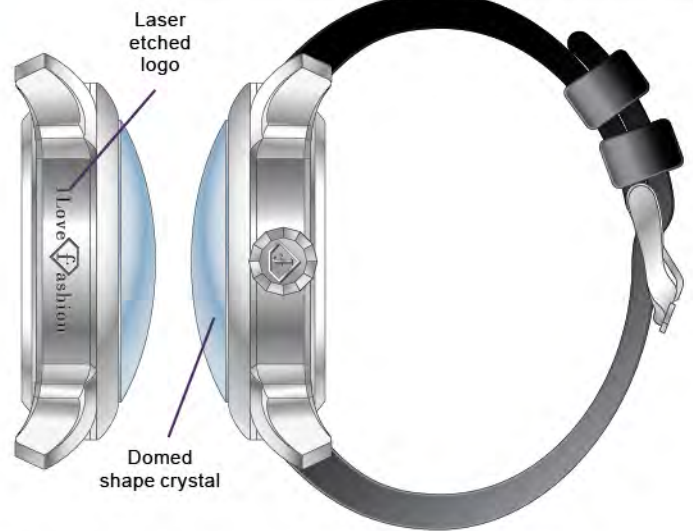
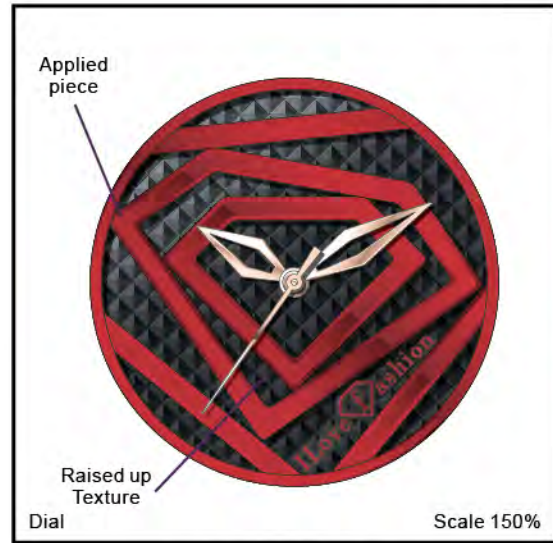

Case construction:

Version 1

- SS brushed and shiny case: 45x 55mm
- SS shiny bezel: 45mm
- Dial opening: 36x36mm
- Matte black raised up texture dial w/silver applied piece
- White croco leather strap: 24 taper to 20mm

Version 2

- IP rose brushed and shiny case: 45x 55mm
- IP rose shiny bezel: 45mm
- Dial opening: 36x36mm
- Matte black raised up texture dial w/red PMS 186C applied piece
- Red PMS 186C croco leather strap: 24 taper to 20mm

Version 3

- GP brushed and shiny case: 45x 55mm
- GP shiny bezel: 45mm
- Dial opening: 36x36mm
- White raised up texture dial w/purple PMS 525C applied piece
- Purple PMS 525C croco leather strap: 24 taper to 20mm

Dial struction:

Applied piece

Base dial w/raised up texture

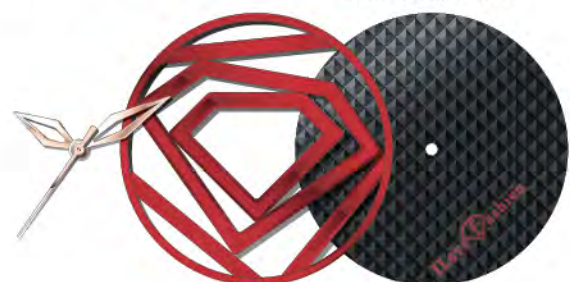



Version 1



Version 2

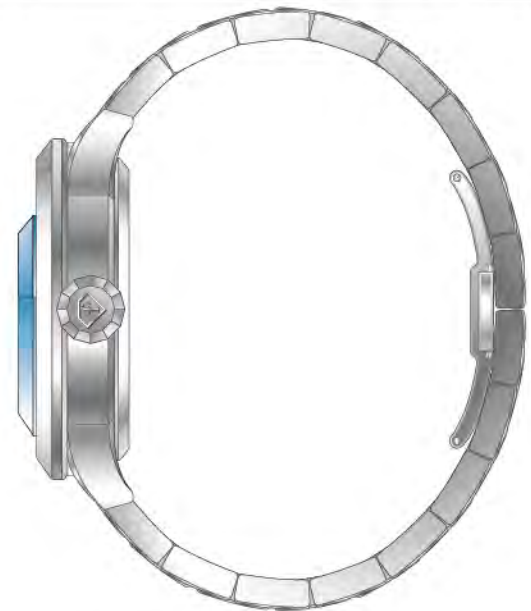
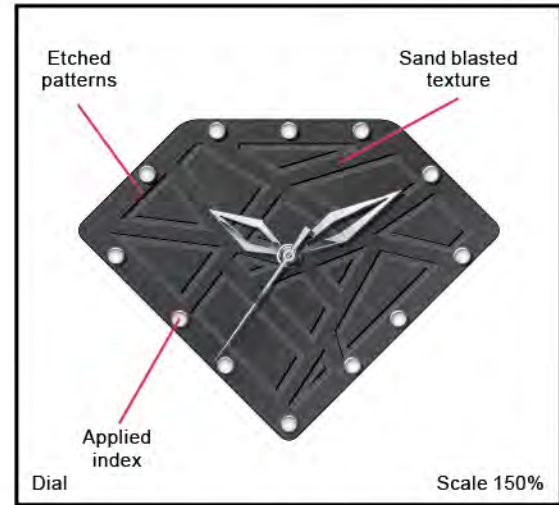

Version 3

1.6mm clear PP stones



Version 4

1.6mm black PP stones

Version 1

- SS sand blasted case: 44x53mm
- SS sand blasted bezel : 45mm w/etched logo
- Dial opening: 37x28mm
- Silver sand blasted texture dial w/etched patterns + silver applied indexes
- SS sand blasted bracelet: 22 taper to 20mm

Version 2

- IP black sand blasted case: 44x53mm
- IP black sand blasted bezel : 45mm w/etched logo
- Dial opening: 37x28mm
- Black sand blasted texture dial w/etched patterns + silver applied indexes
- IP black sand blasted bracelet: 22 taper to 20mm

Version 3

- SS sand blasted case: 44x53mm
- SS sand blasted bezel : 45mm w/etched logo
- Dial opening: 37x28mm
- Silver sand blasted texture dial w/etched patterns + silver applied indexes
- SS sand blasted bracelet: 22 taper to 20mm

Version 4

- IP black sand blasted case: 44x53mm
- IP black sand blasted bezel : 45mm w/etched logo
- Dial opening: 37x28mm
- Black sand blasted texture dial w/etched patterns + silver applied indexes
- IP black sand blasted bracelet: 22 taper to 20mm



Clear PP stones

● 1.6mm x 152pcs.

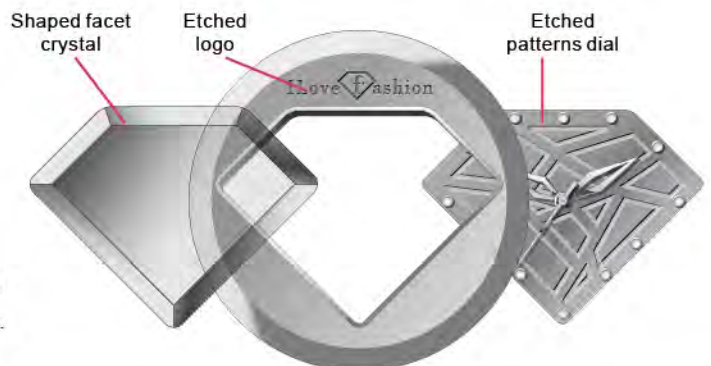



Version 1

Version 2

Version 3

Version 4

Version 1

- IPG Case +Black epoxy
- Case size: 31mmx50.5mm
- Dial opening: 21mm x16mm
- Matt black sunray dial w/ shiny gold logo in center (UP labeling)
- Black leather strap 24mm to16mm(W)

Version 2

- IPS Case + 55 pcs 1.2mm Clear PP stone
- Case size: 31mmx50.5mm
- Dial opening: 21mm x16mm
- Matt black sunray dial w/ shiny silver logo in center (UP labeling)
- Black leather strap 24mm to16mm(W)

Version 3

- IP Rose Gold Case +Black epoxy
- Case size: 31mmx50.5mm
- Dial opening: 21mm x16mm
- Matt black sunray dial w/ shiny rose gold logo in center (UP labeling)
- Black leather strap 24mm to16mm(W)

Version 4

- IP Black Case +Faceted Crystal
- Case size: 31mmx50.5mm
- Dial opening: 21mm x16mm
- Matt black sunray dial w/ shiny gold logo in center (UP labeling)
- Black leather strap 24mm to16mm(W)

Side view



PP Stone
 ○ 1.2mm

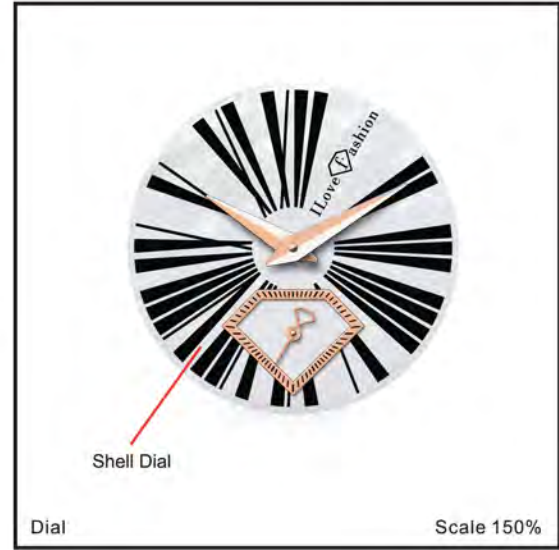

Dial

Scale 150%



Version 1



Version 2

Version 1

- IP rose gold case: 34x39mm
- Dial opening: 27mm
- White Shell Dial
- Black leather strap: 18 to 16mm
- Crown: Ø 5.0mm
- Hands: 8x11.5mm

Version 2

- SS case: 34x39mm
- Dial opening: 27mm
- Black Shell Dial
- Black leather strap: 18 to 16mm
- Crown: Ø 5.0mm
- Hands: 8x11.5mm



Version 1



Side view



Version 2

Version 1

- SS case: 48.3x56mm
- Dial opening: 42.5mm
- White Dial
- Black leather strap: 22mm to 20mm
- Crown: Ø 7.0mm
- Hands: 8.5x11.5mm/3x4mm

Version 2

- IP black case: 48.3x56mm
- Dial opening: 42.5mm
- Black Dial
- Black leather strap: 22mm to 20mm
- Crown: Ø 7.0mm
- Hands: 8.5x11.5mm/3x4mm



Version 1

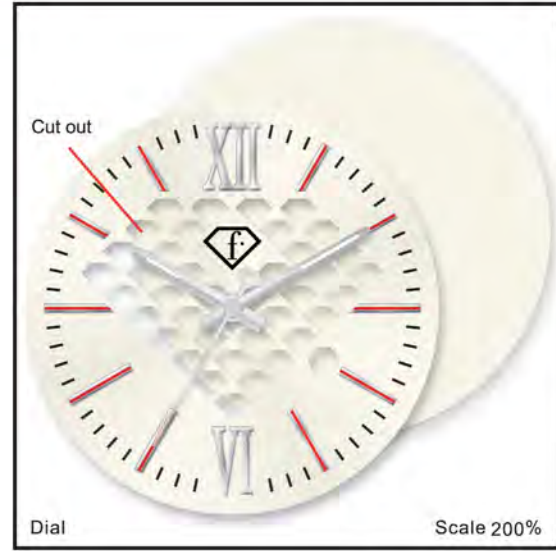

Version 2

Version 1

- SS case: 43x50mm
- Dial opening: Ø36mm
- Black sunray cut out logo Dial black base dial
- Black leather strap : 20mm
- Crown: Ø 7mm
- Hands: 10x14mm

Version 2

- SS case: 43x50mm
- Dial opening: Ø36mm
- Lightyellow sunray cut out logo Dial Lightyellow base dial
- Brown leather strap : 20mm
- Crown: Ø 7mm
- Hands: 10x14mm



fashiontv

Fans style



Version 1



Version 2

Clear PP Stone

- 2.5mm
- 1.5mm

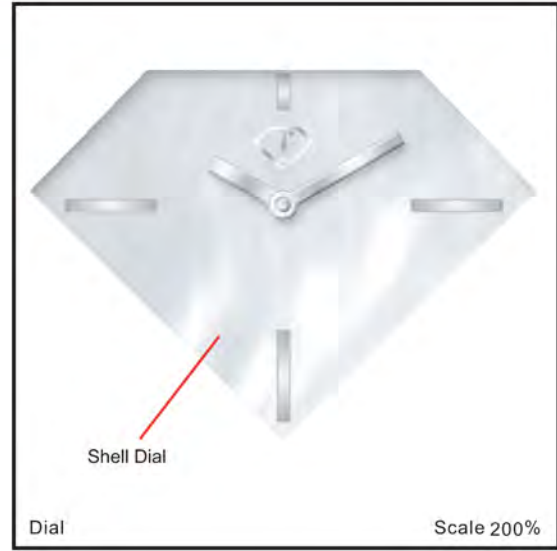

Dial

Scale 200%



Side view

Version 1

- SS case: 40x44mm
- Dial opening: 34.3x25mm
- White Shell Dial
- Black leather strap : 40mm
- Crown: Ø 7mm
- Hands: 5.5x9.0mm

Version 2

- IP Rose Gold case: 40x44mm
- Dial opening: 34.3x25mm
- White Shell Dial
- White leather strap : 40mm
- Crown: Ø 7mm
- Hands: 5.5x9.0mm

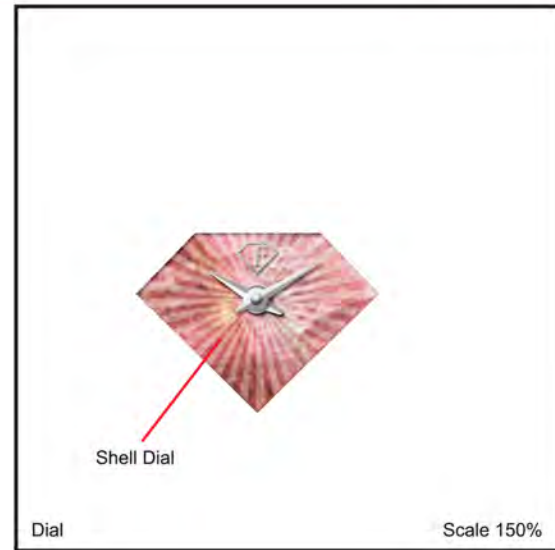

Version 1



Version 2



Version 3

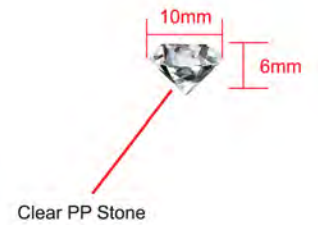

Version 1

- SS case: 30x45mm
- Dial opening: 21.3x15.7mm
- Black Shell Dial
- Black Leather strap : 20 to 20mm
- Crown: Ø 5mm
- Hands: 4x5.5mm

Version 2

- SS case: 30x45mm
- Dial opening: 21.3x15.7mm
- Red Shell Dial
- Red Leather strap : 20 to 20mm
- Crown: Ø 5mm
- Hands: 4x5.5mm

Version 3

- IP rose gold case: 30x45mm
- Dial opening: 21.3x15.7mm
- White Shell Dial
- White Leather strap : 20 to 20mm
- Crown: Ø 5mm
- Hands: 4x5.5mm



PP Stone
 ○ 1.3mm
 ○ 1.0mm

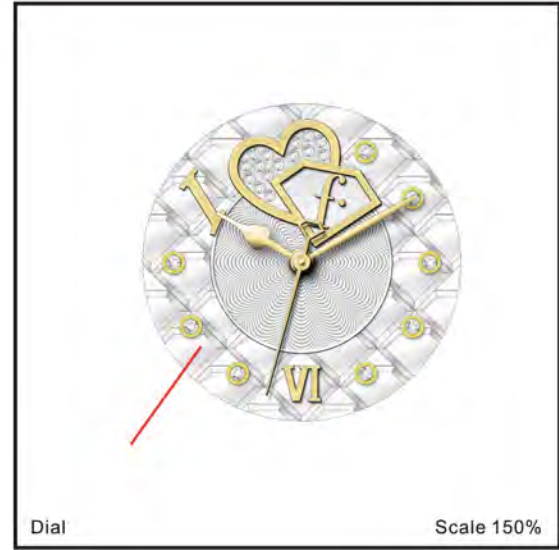

Dial

Scale 150%



Version 1



Version 2

- Version 1
- SS case: 34x39mm
 - Dial opening: 27mm
 - White Shell Dial
 - Black leather strap: 18X16mm
 - Crown: Ø 5.0mm
 - Hands: 8x11.5mm



Version 1



Version 2



Version 3

Clear PP Stone
 ○ 1.8mm

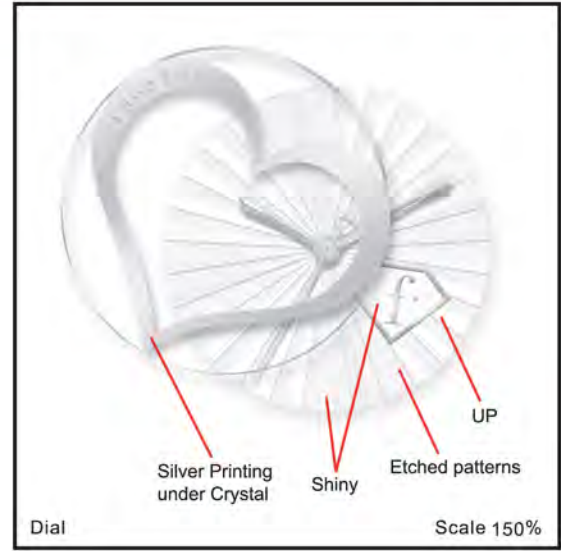

Side view

Version 1

- IP Black case: 36x43mm
- Dial opening: Ø28.5mm
- Black dial
- Plating black under crystal
- Black leather strap : 18mm
- Crown: Ø 6mm
- Hands: 9x12.7mm

Version 2

- SS case: 36x43mm
- Dial opening: Ø28.5mm
- Silver dial
- Plating silver under crystal
- Hot pink leather strap : 18mm
- Crown: Ø 6mm
- Hands: 9x12.7mm

Version 3

- IP Rose Gold case: 36x43mm
- Dial opening: Ø28.5mm
- Silver dial
- Plating rose gold under crystal
- Blue leather strap : 18mm
- Crown: Ø 6mm
- Hands: 9x12.7mm



Version 1

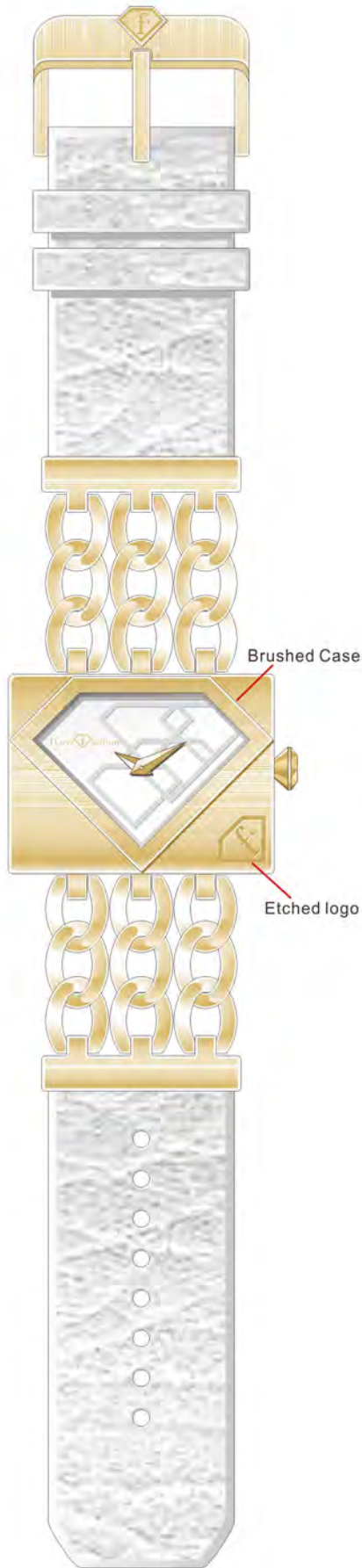

Version 2

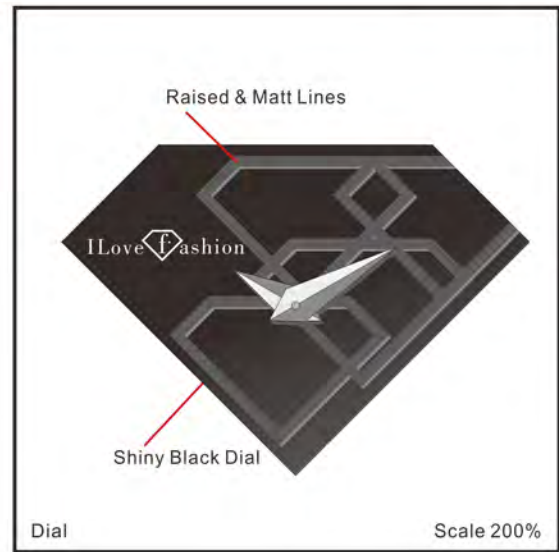

Dial

Scale 200%



Side view

- SS Case: 40mm(w) x 30mm(l)
- Dial Opening: 31mm(w) x 22mm(l)
- SS Chains: 9.5mm(w) x 3 strands
- Leather Strap: 28mm(w)

Version 1

- Horizontal Brushed SS Case
- SS chains
- Black Leather Strap
- Shiny Black Dial with raised & matt lines

Version 2

- Horizontal Brushed IPG Case
- IPG chains
- White Leather Strap
- Shiny White Dial with raised & matt lines



Version 1



Version 2



Version 3



Version 4

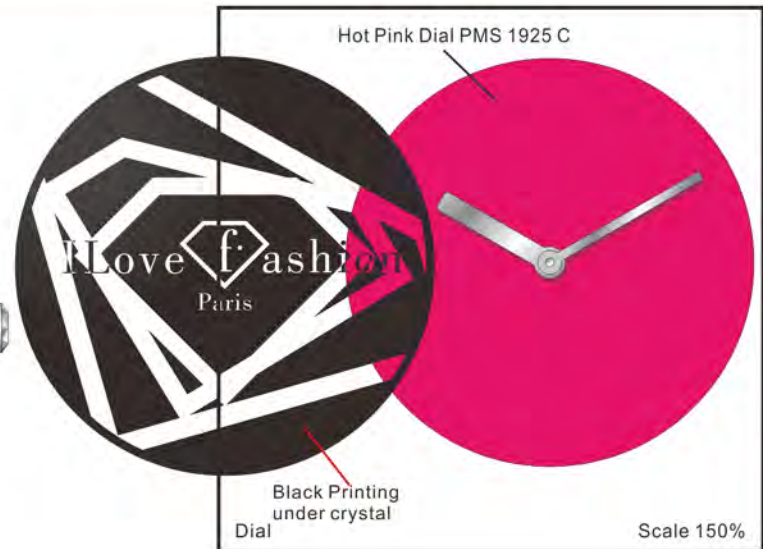

Side view

- SS Case: 40mm(w) x 44.6mm(l)
- Dial Opening: Ø 36mm
- Leather Strap: 22mm(w)

Version 1

- SS Case
- SS Bezel
- Black Leather Strap
- Shiny Hot Pink Dial PMS 1925 C
- Black printing under crystal

Version 2

- SS Case
- SS Bezel
- White Leather Strap
- Shiny White Dial
- Black printing under crystal

Version 3

- SS Case
- IPG Bezel
- Black Leather Strap
- Shiny Gold Dial
- Black printing under crystal

Version 4

- IP Black Case
- IP Black Bezel
- Black Leather Strap
- Matt Grey PMS Cool Grey 11 C Dial
- Black printing under crystal



Version 1

Clear diamond facet crystal w/silver printing

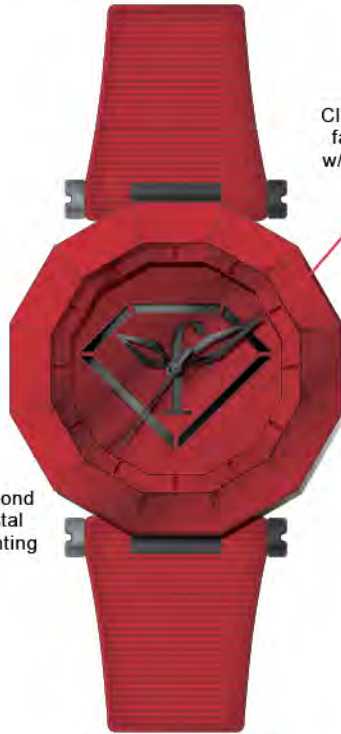

Version 2

Clear diamond facet crystal w/red printing



Version 3

Clear diamond facet crystal w/black printing

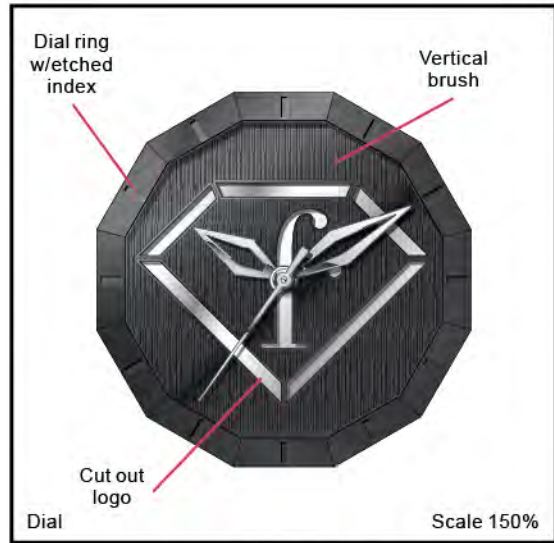

Dial ring w/etched index

Vertical brush

Cut out logo

Dial

Scale 150%

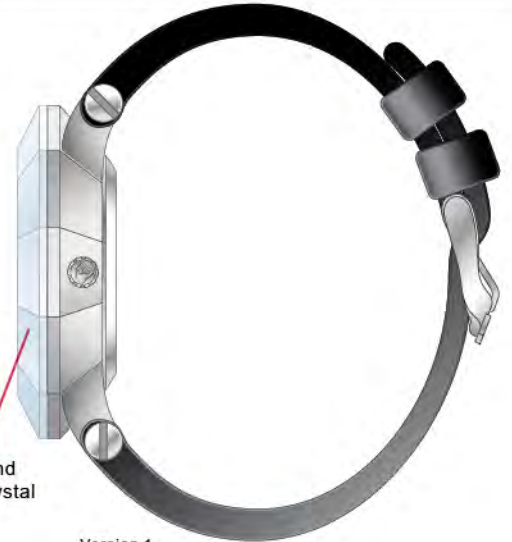

Diamond shape crystal

Version 1

- SS shiny case: 44x 49mm
- Clear diamond facet crystal w/silver printing: 44mm
- Dial opening: 33x33mm
- Silver vertical brush cut out logo dial w/black base dial
- White satin strap: 24 taper to 18mm

Version 2

- IP black shiny case: 44x 49mm
- Clear diamond facet crystal w/red PMS 187C printing: 44mm
- Dial opening: 33x33mm
- Red PMS 187C vertical brush cut out logo dial w/black base dial
- Red PMS 187C satin strap: 24 taper to 18mm

Version 3

- IP black shiny case: 44x 49mm
- Clear diamond facet crystal w/black printing: 44mm
- Dial opening: 33x33mm
- Black vertical brush cut out logo dial w/silver base dial
- Black satin strap: 24 taper to 18mm

Dial struction: Dial ring Top dial w/cut out logo Base silver dial



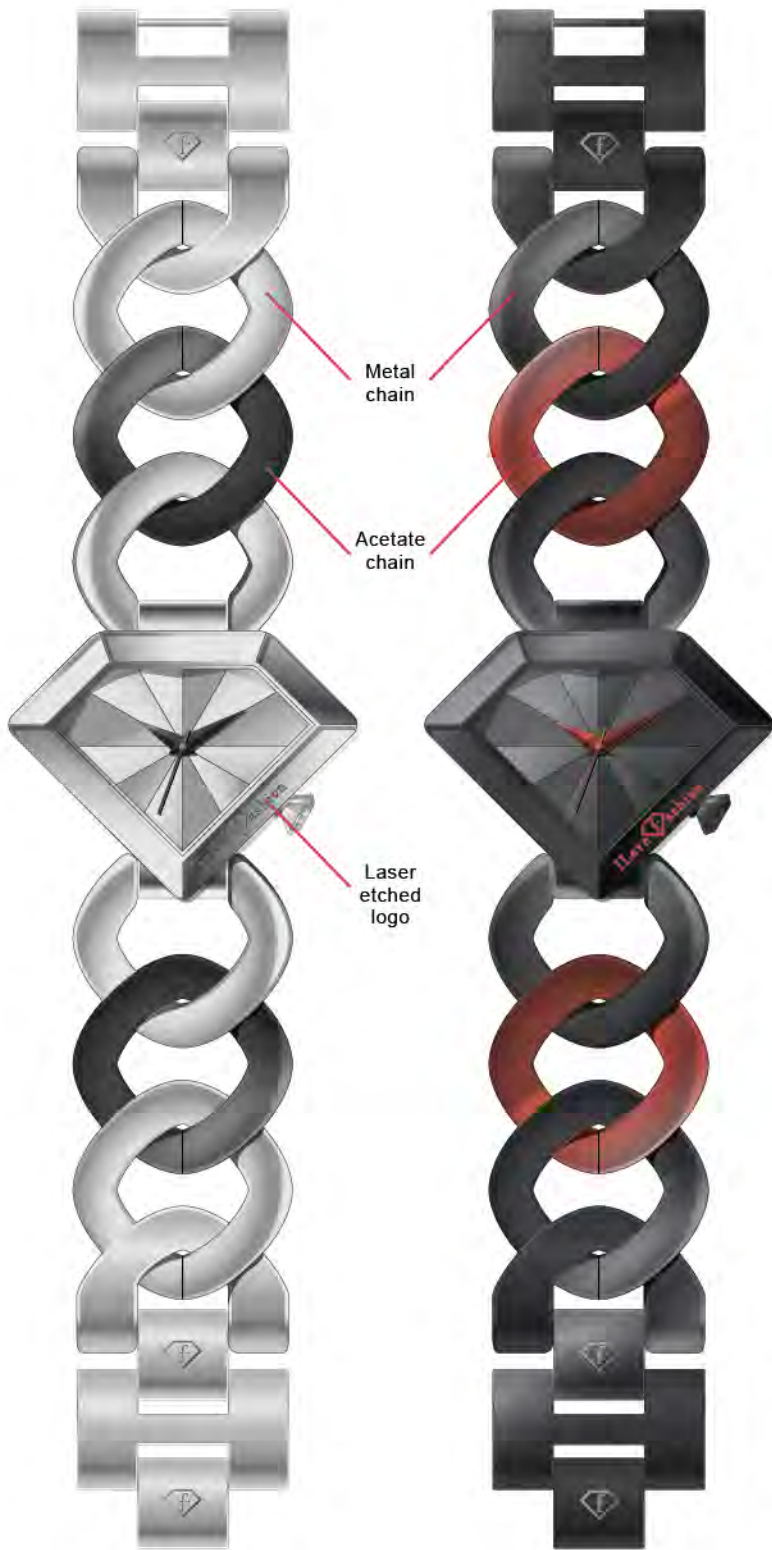

Version 1

Version 2

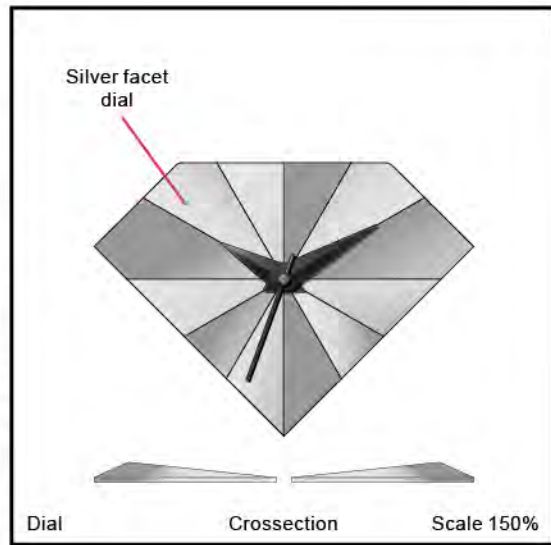

Side view

Version 1

- SS shiny facet case: 46x 35.5mm w/laser etched logo
- Dial opening: 33.5x24mm
- Silver facet dial
- SS + black acetate chain: 29mm
- SS bracelet: 28mm

Version 2

- Matte IP black facet case: 46x 35.5mm w/laser etched logo + red PMS 187 filled
- Dial opening: 33.5x24mm
- Matte black facet dial
- Matte IP black + red PMS 187C acetate chain: 29mm
- Matte IP black bracelet: 28mm

Dial construction:





Version 1



Version 2



Version 3



Version 4



Logo & markers printing under the lens

Dial

Scale 200%

Version 1

- IPG Case
- 30pcs 1.2mm Clear PP Stone
- 14pcs 2.6mm Clear PP Stone
- Case size : 44mm x 50mm
- Dial opening: 27.8mm x 22.8mm
- Black druzy agate dial
- logo & markers printing under the lens
- Black croco leather strap from 22mm to 18mm

Version 2

- IPS Case
- 30pcs 1.2mm Clear PP Stone
- 14pcs 2.6mm Clear PP Stone
- Case size : 44mm x 50mm
- Dial opening: 27.8mm x 22.8mm
- Black druzy agate dial
- logo & markers printing under the lens
- Black glitter leather strap from 22mm to 18mm

Version 3

- IPG Case
- IPG 3D charm
- Case size : 44mm x 50mm
- Dial opening: 27.8mm x 22.8mm
- Black druzy agate dial
- logo & markers printing under the lens
- Hot pink satin leather strap from 22mm to 18mm

Version 4

- IPS Case
- IPS 3D charm
- Case size : 44mm x 50mm
- Dial opening: 27.8mm x 22.8mm
- Black druzy agate dial
- logo & markers printing under the lens
- Neon green satin leather strap from 22mm to 18mm

Sid e view



Version 1



Version 2



Version 4



Version 3



Version 5

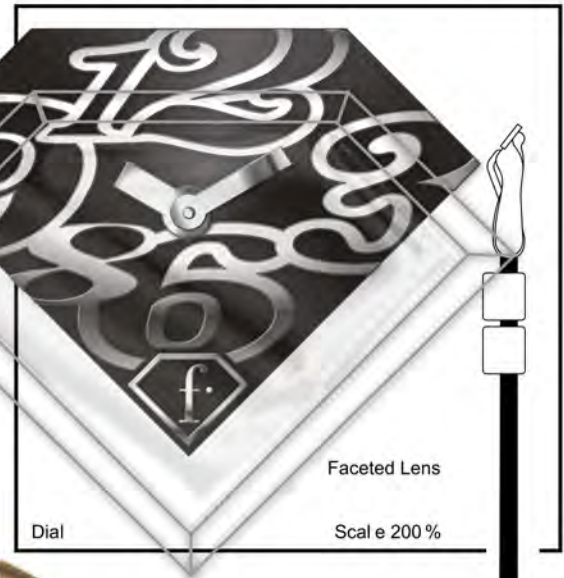

Faceted lens

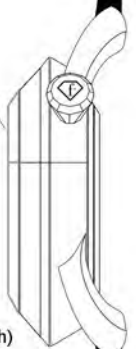

Side view

Version 1

- IP Case
- Case size:49.5mm (w) x 45.5mm (h)
- Dial opening:38.5mm x 28mm
- Matt black sunray dial w/ shiny Silver logo & No.s (UP labeling)
- Black leather strap from 24mm to 20mm

Version 2

- IP Rose Gold Case
- Case size:49.5mm (w) x 45.5mm (h)
- Dial opening:38.5mm x 28mm
- Matt black sunray dial w/ shiny rose gold logo & pink No.s (UP labeling)
- Pink leather strap from 24mm to 20mm

Version 3

- IPG Case
- Case size:49.5mm (w) x 45.5mm (h)
- Dial opening:38.5mm x 28mm
- Matt black sunray dial w/ shiny gold & olive green logo & No.s (UP labeling)
- Olive green leather strap from 24mm to 20mm

Version 4

- IPBlack Case
- Case size:49.5mm (w) x 45.5mm (h)
- Dial opening:38.5mm x 28mm
- Matt black sunray dial w/ shiny silver /red /pink green & blue logo & No.s(UP labeling)
- Black leather strap from 24mm to 20mm

Version 5

- IPBlack Case
- Case size:49.5mm (w) x 45.5mm (h)
- Dial opening:38.5mm x 28mm
- Matt black sunray dial w/ white logo & No.s(UP labeling)
- White leather strap from 24mm to 20mm